



*Temperature Calibrator*

***ZUTEMER 14+***

*User Manual*

[www.zutemer.cz](http://www.zutemer.cz)

# ***Temperature Calibrator***

## **1 Introduction**

This temperature calibrator (the calibrator in the following) is a handheld, battery-operated instrument that measures and sources electrical and physical parameters.

### **Features:**

Measure: DC-voltage, ohm, Tc, RTD, continuity;

Source: DC-voltage, ohm, Tc, RTD;

### **Others features:**

- 2-wire,3-wire,4-wire connection method for ohm and RTD measurement.
- Big LCD can display the TC/RTD measurement value and voltage/resistance corresponding simultaneously.
- TC measurement/source terminals and built-in lead connector of same temperature (RJ compensation with auto-reference joint point)
- Room temperature monitoring under any operation
- Measurement wave-filter function
- Measurement manual-holding function

## **2 Contact Us**

To purchase parts, obtain operation help or address of the vendor or service center nearest to you, please call

us or visit our web (see the bottom page of the Manual).

### 3 Standard Accessories

Make sure that the package contains all the accessories listed below. And if you find they are damaged or any of them is missing, please contact the vendor from which you purchased the product as soon as possible. Refer to the replacing part list in 15.3 in the Manual if you want to order the replacing parts.

- One set of Industrial testing Lead (CL727220)
- A set of Testing Lead (Tp727110)
- A set of Alligator clip (CC807130)
- A quick reference guide
- A User's Manual
- One Fuse 50mA/250V



### 4 Safety Information

For the correct and safe use of the instrument, be sure to follow the cautionary notes stated in this manual whenever handling the instrument. The Company shall not be held liable for any damage resulting from use of the instrument in a manner other than prescribed in the cautionary notes.

A **⚠Warning** identifies conditions and actions that pose hazards to the user; a **Caution** identifies conditions and actions that may damage the meter or the equipment under test.

Refer to Table 1 for the explanation of the international electric symbols adopted by the calibrator or the user's manual.

Table 1 Explanations of International Electrical Symbols

	EARTH GROUND		WARNING INFORMATION
---	--------------	---	------------------------

### **⚠Warning**

To avoid possible electric shock or personal injury:

- Do not apply more than the rated voltage, as marked on the calibrator, between terminals or between any terminal and earth ground;
- Before use, verify the meter's operation by measuring a known voltage;
- Follow all equipment safety procedures;
- Do not use the meter if it is damaged. Before using the meter, inspect the case. Look for cracks or missing plastic. Pay particular attention to the insulation surrounding the connectors;
- Select the proper function and range for the measurement;
- Make sure the battery door is closed and latched before operating the meter;
- Remove test leads from the meter before opening the battery door;
- Inspect the test leads for damaged insulation or exposed metal. Check test lead continuity. Replace damaged test leads before using the meter;
- When using the probes, keep fingers behind the finger guards on the probes;
- Connect the common test lead before connecting the live test lead. When disconnecting test leads, disconnect the live test lead first;
- Do not use the meter if it operates abnormally. Protection may be impaired. When in doubt, have the meter inspect;

- Do not operate this instrument in areas where inflammable or explosive gases or vapor exists. It is extremely hazardous to use the instrument under such environments;
- Do not operate the meter around explosive gas, vapor, or dust;
- Use only type 4 AAA batteries, properly installed in the meter case, to power the meter;
- Do disconnect the testing lead before shifting to different source or measurement functions;
- When servicing the meter, use only specified replacement parts.
- To avoid false reading, which could lead to possible electric shock or personal injury, replace the batteries as soon as the low battery indicator (  ) appears.

### **Caution**

To avoid possible damage to meter or to equipment under test:

- Disconnect the power and discharge all high-voltage capacitors before testing resistance or continuity.
- Use the proper jacks, functions, and ranges for the measurement or source operation.

# 5 Familiar With the Calibrator

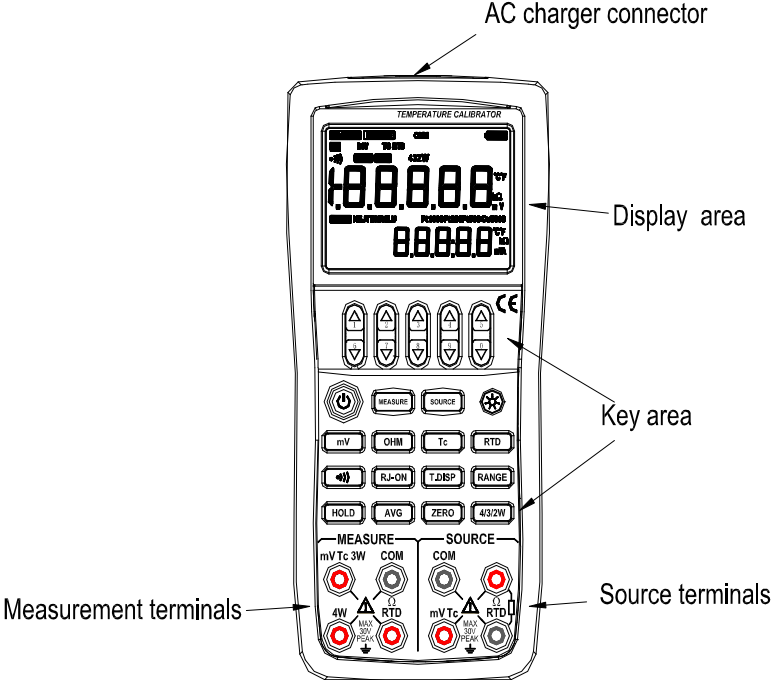

Figure 1 Entire Graph

## 5.1 Measurement/ Source Terminals

Figure 2 shows the measurement /source terminals of the calibrator. Table 2 explains their use.

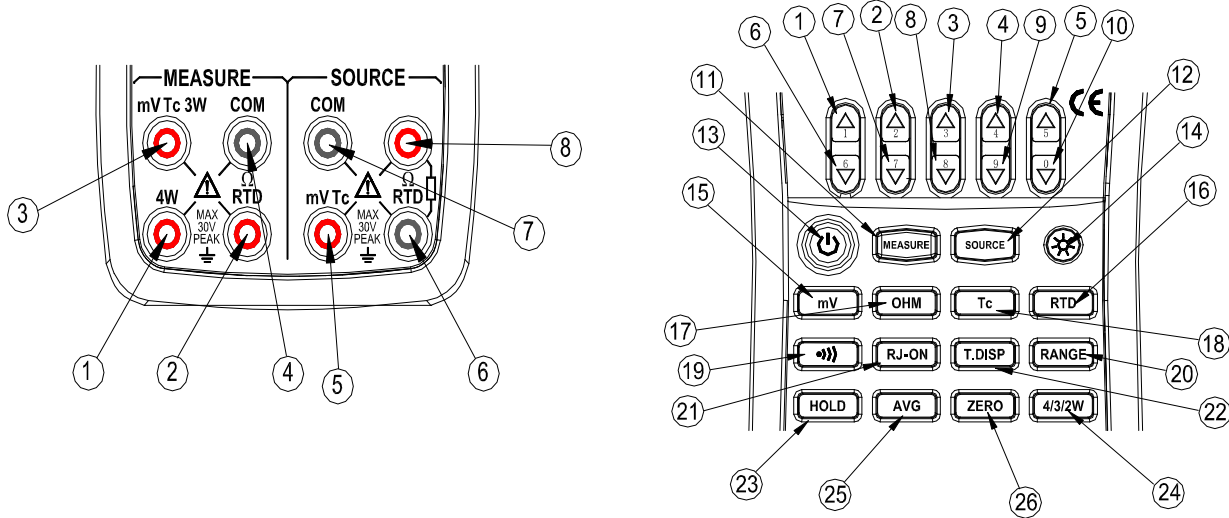

Figure 2 Measurement/ Source Terminals

Figure 3 keys

Table 2 Measurement/ Source Terminals

<b>Terminal</b>	<b>Function</b>
①	4W terminals : measurement terminal of the 4W OHM、 RTD
②	Measurement Signals (+) : OHM、 RTD
③	Measurement Signals (+) : DCV、 TC 3W Terminal: measurement terminal of the 3W OHM、 RTD



④	All the common (return ) (-) terminals of measurement function
⑤	Source Signals: (+) DCV、TC
⑥	Source Signals: (-) OHM、RTD
⑦	All the common (return ) (-) terminals of source function
⑧	Source Signal: (+) OHM、RTD

## 5.2 Keys

Figure 3 shows keys of the calibrator. Table 3 explains their use.

Table 3 Functions of the keys

No.	Name	Function
1~5	Source value set key	Increment of source set point
6~10	Source value set key	Decrement of source set point
11	<b>MEASURE</b> key	Turn on or off measurement function
12	<b>SOURCE</b> key	Turn on or off source function
13	Power key	Turn on or off the power
14	Backlight key	Turn on or off the backlight
15	<b>mV</b> Key	Select measurement/source DC-voltage function

16	<b>RTD</b> Key	Select measurement/source RTD function
17	<b>OHM</b> Key	Select measurement/source OHM function
18	<b>Tc</b> Key	Select measurement/source Tc function
19	<b>•»»</b> Key	Select measurement continuity function
20	<b>RANGE</b> Key	Select measurement/source range
21	<b>RJ-ON</b> Key	In TC measurement /source function, turn on or off the RJ compensation function.
22	<b>T.DISP</b> Key	In TC/RTD measurement /source function, pressing the key, convert the assistance display between room temperature or mV/ $\Omega$ value; On other measurement/source function, pressing the key, turn on or off room temperature display in assistance display.
23	<b>HOLD</b> Key	Measured value holding
24	<b>4/3/2W</b> Key	In ohm/RTD measurement function, select 2W,3W or 4W method.
25	<b>AVG</b> Key	Measuring average value
26	<b>ZERO</b> Key	Set the source value to default value

### 5.3 Display Screen

Figure 4 shows a typical display screen.

- a: Measurement
- b: Source
- c: Measurement/Source resistance
- d: Battery level indicator
- e: Measurement/ Source function on
- f: Measurement/ Source DC-voltage
- n
- g: Measurement/ Source Tc function
- h: Measurement/ Source RTD function
- i: Beeper of measurement continuity
- j: Display –hold for measured value
- k: Average value for measurement
- l: 4/3/2W for Measurement ohm/RTD function
- m: Measurement/Source value
- n: Unit of measured/sourced value
- o: Reference Junction Compensation On
- p: Types of TC measurement / source
- q: Types of RTD measurement / source
- r: room temperature/ Tc(mV) or RTD( $\Omega$ ) subsection value

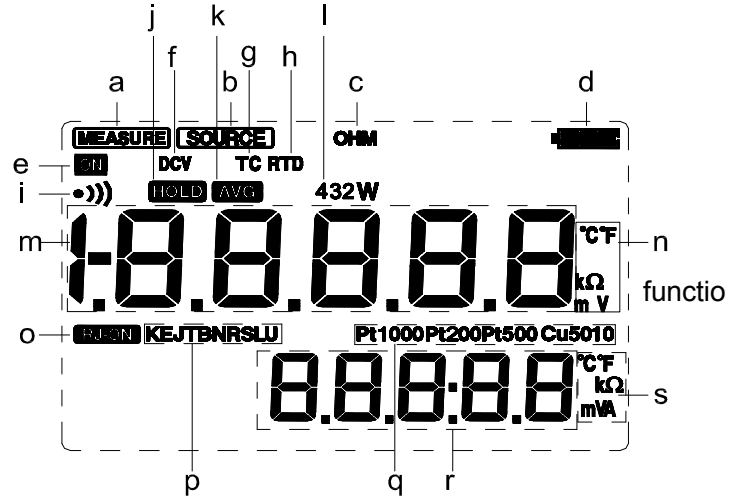

Figure 4 typical LCD display

s: Unit of room temperature/  $T_c$ (mV) or RTD( $\Omega$ ) Unit of subsection value

## 6 Before starting source/measurement

### Operating Precautions

#### Precautions for Safe Use of the Instrument

- When using the instrument for the first time, be sure to read the instructions given in Section Four “Precautions for Safe Use of the Instrument.”
- Do not open the instrument’s case.  
Contact the vendor from which you purchased the instrument, for a service of inspecting or adjusting the internal assembly.
- In case of failure  
Should the instrument begin to emit smoke, give off an unusual odor, or show any other anomaly, immediately turn off the POWER key. If you are using an Charger, disconnect the plug from the wall outlet. Also cut off power to the object under test that is connected to the input terminals. Then, contact the vendor from which you purchased the instrument.
- Charger  
Use an Charger dedicated to the instrument. Avoid placing any load on the Charger, or prevent any heat-emitting object from coming into contact with the adapter.

#### General Handling Precautions

- Before carrying around the instrument turn off power to the object under test, and then the POWER key of the instrument. If you are using an Charger, disconnect the power cord from the wall outlet. Finally,

detach all lead cables from the instrument. Use a dedicated carry case when transporting the instrument.

- Do not bring any electrified object close to the input terminals, since the internal circuit may be destroyed.
- Do not apply any volatile chemical to the instrument's case or operation panel. Do not leave the instrument in contact with any product made of rubber or vinyl for a prolonged period. Be careful not to let a soldering iron or any other heat-emitting object come into contact with the operation panel, as the panel is made of thermoplastic resin.
- Before cleaning the instrument's case or operation panel disconnect the power cord plug from the wall outlet if you are using an Charger. Use a soft, clean cloth soaked in water and tightly squeezed to gently wipe the outer surfaces of the instrument. Ingress of water into the instrument can result in malfunction.
- If you are using an Charger with the instrument and will not use the instrument for a prolonged period, disconnect the power cord plug from the wall outlet.
- For handling precautions regarding the batteries, see "Installing or Replacing the Batteries".
- Never use the instrument with the cover of the battery holder opened.

### **Environmental Requirements**

Use the instrument in locations that meet the following environmental requirements:

- Ambient temperature and humidity

Ambient temperature range: 0 to 50°C

Ambient humidity range: 20 to 80% RH. Use the instrument under non-condensing condition.

- Flat and level locations

### **Do not use the instrument in locations that are**

- Exposed to direct sunlight or close to any heat source.

- Exposed to frequent mechanical vibration.
- Close to any noise source, such as high-voltage equipment or motive power sources.
- Close to any source of intensive electric or electromagnetic fields.
- Exposed to large amounts of greasy fumes, hot steam, dust or corrosive gases.
- Exposed to unstable or a risk of explosion due to the presence of flammable gases.

**Note:**

- Use the instrument under the following environmental conditions if precise source or measurement is your requirement:

Ambient temperature range:  $23 \pm 5^{\circ}$  C;

Ambient humidity range: 20 to 80% RH(non-condensing)

- When using the instrument within a temperature range of 0 to 18° C or 28 to 50° C, add a value based on the temperature coefficient shown in Chapter 18“Specifications” to the given accuracy rating.
- When using the instrument at an ambient humidity of 30% or lower, prevent electrostatic charges from being produced, by using an antistatic mat or any other alternative means.
- Condensation may occur if you relocate the instrument from places with low temperature and humidity to places with high temperature and humidity, or if the instrument experiences any sudden temperature change. In that case, leave the instrument under the given ambient temperature for at least one hour to ensure that the instrument is free from condensation, before using the instrument.

**Installing or Replacing the Batteries**

**⚠Warning**

To avoid electrical shock, always remove the source or measurement lead cables from the object under test,

as well as from the instrument itself.

### **Caution**

- To avoid the risk of fluid leakage or battery explosion, install batteries with their positive and negative electrodes correctly positioned.
- Do not short-circuit the batteries.
- Do not disassemble or heat the batteries or throw them into fire.
- When replacing batteries, replace all of the four batteries at the same time with new ones from the same manufacturer.
- If the instrument will not be used for a prolonged period, remove the batteries from the instrument.

**Step 1:** Remove the lead cables and charger and turn off the calibrator before you begin installing batteries.

**Step 2:** Remove the battery holder cover by sliding it in one-quarter counterclockwise direction and turn off the calibrator.

**Step 3:** Install four alkaline batteries of same type in the battery holder with their positive and negative electrodes positioned correctly as indicated on the holder.

**Step 4:** After replacement, reattach the battery holder cover.

### **Indication of Battery Level**

The battery replacement indicator shows the battery level in five steps according to the measured voltage of the batteries.

Full battery: 

The battery level is below 50% full: 

The battery level is below 25% full: 

Low battery: 

The dictation flashes in sequence when getting charged.

Note that the battery replacement indicator is driven by directly measuring the battery voltage when the calibrator is in actual operation. Consequently, the indicator may read differently depending on the battery load condition (e.g., the load condition of the source output or on/ off state of the measurement function) if the batteries are too low.

## **Connecting the Charger**

### **Warning**

- Make sure the voltage of the AC power source matches the rated supply voltage of the Charger, before connecting the Charger to the AC power source.
- Do not use any Charger other than the dedicated Charger from the Company.
- Do not charge non Ni-Cd, Ni-MH batteries or wasted batteries.

**Step 1:** Make sure the calibrator is turned off.

**Step 2:** Insert the plug of the optional Charger into the Charger connection jack.

### **Note**

- Turn off the calibrator before connecting or disconnecting the Charger from AC power, plugging in/out the



Charger connection jack.

- Plug out the Charger from the Charger connection jack of the calibrator when discharging.
- Do not charge the calibrator without any battery in.

### **Turning On the Power**

Pressing the Power key once when the power is off turns on the calibrator.

Pressing the Power key for 2 seconds turns off the calibrator.

### **Automatic Power-off**

When the calibrator is running on batteries and no key is operated for approximately ten minutes, the calibrator turns off automatically. The automatic power-off time could be reset in the factory default parts, see Chapter 10 “Factory Default”.

### **Turning On/Off the Backlight**

Pressing the key turns on the backlight, while pressing the key once again turns it off. This feature makes it easier for you to view the LCD when operating the calibrator in dark places or when carrying out source or measurement. Battery life shortens when the calibrator is operated on batteries.

### **Note**

The backlight automatically turns off after 10 seconds. Press the key once more to relight it.

The time could be reset in the factory default parts, see Chapter 10 “Factory Default”.

## **7 Source**

From the calibrator, you can source a DC voltage, resistance, thermocouple, RTD.

### **Warning**

To avoid electrical shock, do not apply more than the rated voltage, as marked on the calibrator, between terminals or between any terminal and earth ground. Always use the calibrator in locations with a voltage to ground below 30 Vpk.

### Caution

- The instrument has been calibrated without taking into account a voltage drop due to the resistance component of the lead cables for source. Care must be taken therefore when drawing a load current since the voltage drop due to the resistance component (approximately  $0.1 \Omega$  on a round-trip basis) of the lead cables serves as an error.

## 7.1 Connecting Cables to Terminals

### For DC voltage, thermocouple (Figure 5)

Figure 5 Sourcing DC voltage, TC

**Step 1:** Connect the black lead cable for source to the COM output terminal and the red lead cable to the “mVTc” output terminal.

**Step 2:** Connect the other ends of the cables to the input of equipment under test while making sure the polarities are correct.

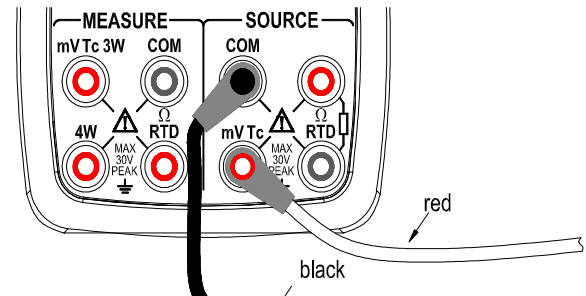

### For resistance and RTD signal (Figure 6)

**Step 1:** Connect black lead cables for source to the black terminal of  $\Omega$ 、RTD and the red lead cable to the red terminal of  $\Omega$ 、RTD.

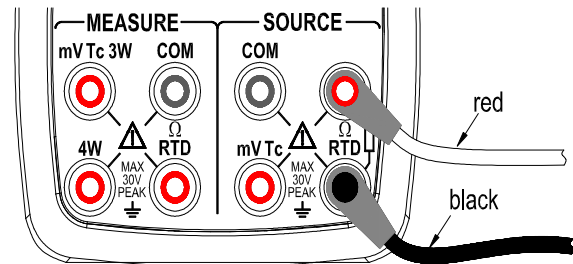

**Step 2:** Connect the other ends of the cables to the input of equipment under test while making sure the polarities are correct.

Figure 6 Sourcing Resistances and RTD

## 7.2 Sourcing DC Voltage

**Step 1:** Using the (mV) key to select DC voltage source function, select the desired range from 100mV, 1000mV by pressing the (RANG) key. The default value and unit of the selected source function and range shall be displayed in the main districts part of the LCD.

**Step 2:** Set the output value digit by digit using (▲) / (▼) keys.

Each pair of (▲) / (▼) keys corresponds to each digit of the LCD reading. Each press of the (▲) / (▼) key increases or decreases the digit. Increasing the digit from 9 or decreasing it from 0 causes the digit to overflow or underflow, allowing you to set the output value without interruption. Holding down the (▲) / (▼) key continuously changes the digit in question. And the value won't change if it is increased or decreased to the Maxim or Minimum value. Pressing the (ZERO) key initializes the output set point to the default value (0).

**Step 3:** The calibrator sources the DC-voltage signal between the output terminals.

## 7.3 Sourcing Resistance

- Firstly, the calibrator sources a resistance signal by receiving the resistance-measuring current  $I$  supplied from the device being calibrated (such as a resistance meter) and then delivering the voltage  $V$  proportional to the preset resistance  $R$  between the output terminals, and thus producing the equivalent resistance  $R = V/I$ . Consequently, the calibrator sources the signal correctly only for such devices that

employ this method of measurement.

- The allowable range of the resistance measuring current  $I$  that the calibrator receives from a resistance measuring device under calibration is rated as 0.1 mA to 3 mA. To ensure accuracy, the resistance measuring current  $I$  from the device under calibration shall be strictly confined within the range. For further details, see Chapter 17, “Specification”.
- Any resistance signal being sourced does not include the resistance component of the lead cables for source. The whole resistance, when measured at the ends of the lead cables for source, is given by adding the resistance of the lead cables (approximately  $0.1\Omega$  on a round-trip basis) to the sourced resistance signal. For source of precise resistance signals, use three-wire or four-wire connection.
- If capacitance between the terminals of a device under calibration is greater than  $0.1\mu\text{F}$ , the calibrator may fail to source correct resistance signals.

**Step 1:** Using the ( **OHM** ) key to select Ohm function. Using the ( **RANGE** ) key, select the desired range. The selected function and the default range source value and unit shall be shown in the main districts part of the LCD.

**Step 2 :**Set the output value digit by digit using each pair of ( **▲** ) / ( **▼** ) keys.

Each pair of ( **▲** ) / ( **▼** ) keys corresponds to each digit of the LCD reading. Each press of the ( **▲** ) / ( **▼** ) key increases or decreases the digit. Increasing the digit from 9 or decreasing it from 0 causes the digit to overflow or underflow, allowing you to set the output value without interruption. Holding down the ( **▲** ) / ( **▼** ) key continuously changes the digit in question. And the value won't change if it is increased or decreased to the Maxim or Minimum value. Pressing the ( **ZERO** ) key initializes the output set point to the default value(0).

**Step 3:** The calibrator sources the preset resistance value between the output terminals.

## 7.4 Simulate Sourcing TC

The calibrator is designed with an internal temperature sensor. To calibrate a device with built-in reference junction temperature compensation by sourcing a thermoelectromotive force with the calibrator without using non-external 0°C reference junction compensation means, use the RJ sensor function. Select simulate TC source function, in which RJ sensor goes on work automatically. The “RJ-ON” mark displays on the screen.

**Step 1:** Using the ( **TC** ) key, select simulate TC source function. Using the ( **RANGE** ) key, select the desired range from K, E, J, T, B, N, R, S, L, U. The selected function and the default range source value and unit shall be shown in the main districts part of the LCD.

**Step 2 :**Set the output value digit by digit using each pair of ( ▲ ) / ( ▼ ) keys.

Each press of the ( ▲ ) / ( ▼ ) key increases or decreases the digit. Increasing the digit from 9 or decreasing it from 0 causes the digit to overflow or underflow, allowing you to set the output value without interruption. Holding down the ( ▲ ) / ( ▼ ) key continuously changes the digit in question. And the value won't change if it is increased or decreased to the Maxim or Minimum value. Pressing the ( **ZERO** ) key initializes the output set point to the default value(the default value of a typical B type is 600°C).

**Step 3:** A thermoelectromotive force based on the temperature detected by the RJ sensor develops between the output terminals.

Note:

If you don't need the reference junction compensation, press the ( **RJ-ON** ) key to shut off. The calibrator source a value with using external 0°C reference junction compensation means, and the “RJ-ON” mark vanishes. Press the ( **RJ-ON** ) key once more to start the reference junction compensation and the “RJ-ON” mark displays on the screen.

## Tips:

- The temperature unit is defaulted as °C. To convert into °F, see Chapter 10 “Factory Default” .

### 7.4.1 Temperature Monitor Function

The calibrator offers a temperature monitor function, which is convenient for the user to observe the voltage value sourced between the output terminals in TC source function.

In TC source function, the assistance district of the LCD shows the voltage value sourced between the output terminals, (varies responding to the changes of the reference junction compensation). Pressing the (**T.DISP**) key once more, the assistance district of the LCD shows the preset room temperature value.

### 7.5 Sourcing RTD

- Firstly, the calibrator sources a resistance signal by receiving the resistance-measuring current  $I$  supplied from the device being calibrated (such as a resistance meter) and then delivering the voltage  $V$  proportional to the preset resistance  $R$  between the output terminals, and thus producing the equivalent resistance  $R = V/I$ . Consequently, the calibrator sources the signal correctly only for such devices that employ this method of measurement.
- The allowable range of the resistance measuring current  $I$  that the calibrator receives from a resistance measuring device under calibration is rated as 0.1 to 3 mA at PT100, Cu10, Cu50, 0.05 to 0.3 mA at PT200, PT500, PT1000. To ensure accuracy, the resistance measuring current  $I$  from the device under calibration shall be strictly confined within the range. For further details, see Chapter 17, “Specification”.
- Any resistance signal being sourced does not include the resistance component of the lead cables for source. The whole resistance, when measured at the ends of the lead cables for source, is given by adding the resistance of the lead cables (approximately  $0.1\Omega$  on a round-trip basis) to the sourced

resistance signal.

**Step 1:** Using the ( **RTD** ) key, select RTD function. Using the ( **RANGE** ) key, select a desired RTD range from PT100, PT200, PT500, PT1000, Cu10, Cu50. The selected function and the default range source value and unit shall be shown in the main district of the LCD and the type of the RTD shall be shown in middle port of the LCD.

**Step 2 :**Set the output value digit by digit using each pair of ( ▲ ) / ( ▼ ) keys.

Each press of the ( ▲ ) / ( ▼ ) key increases or decreases the digit. Increasing the digit from 9 or decreasing it from 0 causes the digit to overflow or underflow, allowing you to set the output value without interruption. Holding down the ( ▲ ) / ( ▼ ) key continuously changes the digit in question. And the value won't change if it is increased or decreased to the Maxim or Minimum value. Pressing the ( **ZERO** ) key initializes the output set point to the default value(0).

**Step 3:** The calibrator sources the preset resistance value between the output terminals.

### **7.5.1 Temperature Monitor Function**

The calibrator offers a temperature monitor function, which is convenient for the user to observe the resistance value sourced between the output terminals.

In RTD source function, LCD shows the resistance value sourced between the output terminals. Pressing the ( **T.DISP** ) key once more, the assistance districts of the LCD shows the preset room temperature value.

### **7.6 Zero-off function**

In any range of DC voltage, ohm, TC and RTD functions, pressing the ( **ZERO** ) key selects clearing off function, which initializes the preset source value for the convenience of user to reset source value.

## 8 Measurement

From the calibrator, you can measure a DC voltage, resistance, thermocouple, RTD and continuity.

### ⚠Warning

- In an application where the calibrator is used together with the supplied lead cables for measurement, the allowable voltage to ground of the input terminals is 30 V<sub>peak</sub> maximum. To avoid electrical shock, do NOT use the calibrator at any voltage exceeding the maximum voltage to ground.
- The allowable voltage to ground when the supplied thermocouple convertor is attached to the input terminals is 30V peak maximum. To avoid electrical shock, do not use the terminal adapter for measuring any circuit voltage exceeding the maximum voltage to ground.

### Tips:

- With the **(HOLD)** key, you can hold the measured value.
- The reading of a measured value is updated differently responding to different measurement function. LCD shows “ - - - - ” on the upper part when shifting the range. If the input is over ranged, the measured value on the LCD reads as “oL”.

### 8.1 Connecting Cables to Terminals

#### For DC voltage measurement (Figure 7)

**Step 1:** Connect the black lead cable for measurement to

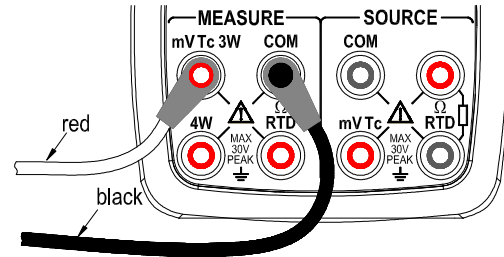



the "COM" input terminal and the red lead cable to the "mVTc3W" input terminal.

**Step 2:** Connect the other end of the cable to the measuring terminals of equipment under test while making sure the polarities are correct.

Figure 7 Measuring DC

### For thermocouple signal (Figure 8)

**Step 1:** Connect the thermocouple converter to the input terminals. This will help you connect the cables easily.

**Step 2:** Connect between TC terminals. The positive output lead wire of the thermocouple to the H terminal of the thermocouple converter and the negative output lead wire to the L terminal.

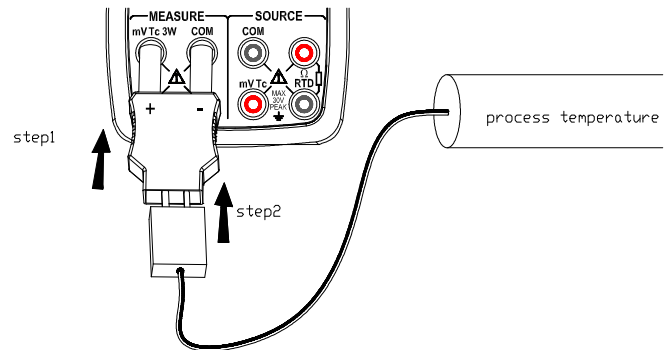

Figure 8 Measuring TC

## Two wire connection method for continuity, ohm/RTD signal (Figure 9)

**Step 1:** Connect one black lead cable for measurement to the “COM” input terminal and Connect the red lead cable to the “ΩRTD” input terminal.

**Step 2:** Connect the two clips of the cables to the measuring terminals of equipment under test while making sure the polarities are correct.

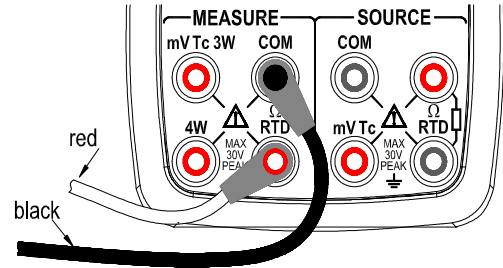

Figure 9 Measuring continuity ,ohm/RTD signal with 2w

method

## Three wire connection method for ohm/RTD signal (Figure 10)

**Step 1:** Connect one black lead cable for measurement to the “COM” input terminal and another black lead to the “mVTc3W” terminal. Connect the red lead cable to the “ΩRTD” input terminal.

**Step 2:** Connect the three clips of the cables to the measuring terminals of equipment under test while making sure the polarities are correct.

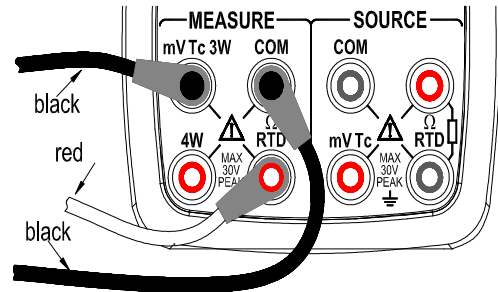

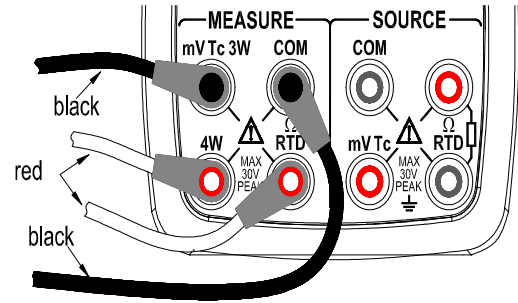

Figure 10 ohm/RTD signal with 3w method

#### Four wire connection method for ohm/RTD signal (Figure 11)

**Step 1:** Connect one black lead cable for measurement to the “COM” input terminal and another black lead to the “mV Tc 3W” terminal. Connect one red lead cable to the “RTD” input terminal and another red lead to “4W” terminal.

**Step 2:** Connect the four clips of the cables to the measuring terminals of equipment under test while making sure the polarities are correct.

#### **⚠Warning**

- Before connecting the calibrator to the device under test, cut off the power to the device.

#### **⚠Warning**

If you make a mistake in wiring or in the operating procedure in this measurement task, there will be a danger

Figure 11 ohm/RTD signal with 4w method

of not only damage to the instrument but also personal injury due to electrical shock. Exercise the utmost care when carrying out the measurement task.

## **8.2 Measuring DC Voltage**

**Step 1:** Make sure the lead cables for measurement are not connected to the measuring instrument under test.

**Step 2:** Using the (**mV**) key, select DC Voltage measurement function.

**Step 3:** Connect the lead cables for measurement to the measuring terminals of the measuring instrument under test.

**Step 4:** Using the (**RANGE**) key, select a desired range from 50mV, 500mV. The selected function and the measured value and unit shall be shown in the main districts part of the LCD.

## **8.3 Measuring Resistance**

**Step 1:** Make sure the lead cables for measurement are not connected to the measuring instrument under test.

**Step 2:** Using the (**OHM**) , select resistance measurement function.

**Step 3:** Connect the lead cables for measurement to the measuring terminals of the measuring instrument under test as shown in Figure 9, Figure 10 or Figure 11.

**Step 4:** Using the measurement (**RANGE**) key, select the desired range from 500Ω,5K. The selected function and the measured value and unit shall be shown in the main districts part of the LCD.

## **8.4 Measuring Temperature with Thermocouple (TC)**

### **Note:**

Any voltage higher than 30Vpk won't work on the measured circuit if applying the thermocouple convertor to

the given input terminal.

**Step 1:** Make sure the lead cables for measurement are not connected to the measuring instrument under test.

**Step 2:** Using the ( **TC** ) key, select TC measurement function. Using the measurement ( **RANGE** ) key, select the desired range from K, E, J, T, B, N, R, S, L,U.

**Step 3:** Connect the thermocouple convertor to the jack under test as shown in Figure 8.The selected function and the measured value and unit shall be shown in the main districts part of the LCD.

**Tips:**

- If there has been a sudden change in the operating ambient temperature of the calibrator, wait until the built-in reference junction compensation stabilizes. Avoid using the calibrator in locations exposed to wind from such apparatus as an airconditioner.

**8.4.1 Using RJ sensor**

Select TC measurement function, in which RJ sensor goes on work automatically, press ( **RJ-ON** ) key to shut off. Both the “RJ-ON” mark and the environmental temperature display vanish. Press the ( **RJ-ON** ) key once more to start the reference junction compensation and the “RJ-ON” mark displays on the middle of the screen, and the environmental temperature displays on the screen.

**8.4.2 Temperature Monitor Function**

The calibrator offers a temperature monitor function, which is convenient for the user to observe the voltage value measured from the input terminals.

In TC measurement function, LCD shows the voltage value measured between the input terminals. Pressing the ( **T.DISPLAY** ) key again, LCD shows the measured room temperature value in the assistance districts part

of the LCD.

## 8.5 Measuring Temperature with RTD

**Step 1:** Make sure the lead cables for measurement are not connected to the measuring instrument under test.

**Step 2:** Using the ( **RTD** ) key, select RTD measurement function.

**Step 3:** Connect the lead cables for measurement to the measuring terminals of the measuring instrument under test as shown in Figure 9, Figure 10 or Figure 11.

**Step 4:** Using the measurement ( **RANGE** ) key, select a desired range from PT100,PT200,PT500,PT1000,Cu10,C50.The selected function and the default measured value and unit shall be shown in the main districts part of the LCD.

### Tips:

- The calibrator offers the 2-wire/3-wire/4-wire connection method when measuring ohm/RTD.

### 8.5.1 Temperature Monitor Function

The calibrator offers a temperature monitor function, which is convenient for the user to observe the resistance value measured from the input terminals.

In RTD measurement function, LCD shows the resistance measured between the input terminals. Pressing the ( **T.DISPLAY** ) key again, LCD shows the measured room temperature value in the assistance districts part of the LCD.

## 8.6 Measuring Continuity

Continuity measurement is used to detect the intactness of the circuit (e.g. a resistance lower than 50). Using

the (•)) ) , select continuity measurement function. LCD displays continuity symbol “•))” on the upper part.

Connecting the devices as shown in Figure 9, the beeper sounds continuously if the loop circuit resistance under measurement is less than 50Ω, and LCD shows the present measured resistance value.

### **8.7 Measurement-filtering function**

Selecting measurement-filtering function stabilizes the measured value displayed on LCD.

In DCV, OHM, TC, RTD function, pressing the (AVG) key causes calculation of the average of the samples. LCD shows the “AVG” symbol. Repeating the (AVG) key cancels the calculation and the “AVG” symbol disappears.

### **8.8 Measured Value holding function**

Apart from the continuity measurement functions, the reading-hold function can also be used to preserve the current measured value on the main districts part of LCD, which consequently doesn't refresh the measured value.

Pressing the (HOLD) key selects reading-hold mode, and LCD displays “HOLD” symbol. To cancel the selection, press the (HOLD) key again and the “HOLD” symbol disappears.

## **9 Environmental Temperature Test**

The calibrator can measure the surrounding environmental temperature. After turning on the calibrator, to observe the surrounding environment, pressing the (T.DISP) key causes LCD displays the room temperature value and the unit in the assistance districts part of the LCD. Repeating the (T.DISP) key cancels the room temperature value.

## 10 Factory Default

You can reset the factory default of the calibrator.

When turning on the calibrator, pressing the (HOLD) key immediately to enter the default set.

### 10.1 Setting Auto -power off time

**Step 1:** When entering the default set, LCD displays “AP.OFF” symbol on the upper part, indicating automatic power- off setting mode.

**Step 2:** Set the time within 0-60 minute range by using the second pair of (▲)/(▼) counting from right to left. Each press of the (▲) / (▼) key causes 10 -minute increments or 10- minute decrement with constant setting. Constant press of the key causes increments or decrement of the value in sequence. The value won't change when reaching the maximum or minimum value. The time unit is minute.

**Step 3:** Pressing the (SOURCE) key, LCD displays “SAVE” symbol on the upper part for 1s.

#### Tips:

Zero default value (0) represents no automatic power-off function.

### 10.2 Setting Backlight time

**Step 1:** Pressing the (MEASURE) key ,LCD displays “BL.OFF” symbol on the upper part, indicating backlight time setting mode.

**Step 2:** Set the time by using the pair of (▲) / (▼) . And the unit is second.

Each pair of (▲) / (▼) keys corresponds to each digit of the LCD reading. Each press of the (▲) / (▼) key increases or decreases the digit. Increasing the digit from 9 or decreasing it from 0 causes the digit to overflow or underflow, allowing you to set the output value without interruption. Holding down the (▲) / (▼)



key continuously changes the digit . And the value won't change if it is increased or decreased to the Maxim or Minimum value. The setting range is confined within 0-3600 seconds.

**Step 3:** Pressing the ( **SOURCE** ) key, LCD displays "SAVE" symbol on the upper part for 1sec.

#### **Tips:**

When the default value is 0, the backlight won't be off automatically if turned on except that you turn it off manually.

### **10.3 Setting temperature unit**

**Step 1:** Pressing the ( **MEASURE** ) key ,LCD displays "TEM.U" symbol on the upper part, indicating temperature unit setting mode.

**Step 2:** Shifting between the °C and °F by using the right pair of (▲) / (▼) .

**Step 3:** Pressing the ( **SOURCE** ) key, LCD displays "SAVE" symbol on the upper part for 1s.

### **10.4 Setting frequency**

**Step 1:** Pressing the ( **MEASURE** ) key ,LCD displays "FRSET" symbol on the upper part, indicating frequency setting mode.

**Step 2:** Shifting between the 50Hz and 60Hz by using the right pair of (▲) / (▼) .

**Step 3:** Pressing the ( **SOURCE** ) key, LCD displays "SAVE" symbol on the upper part for 1s.

### **10.5 Factory default**

**Step 1:** Pressing the ( **MEASURE** ) key ,LCD displays "FACRY" symbol on the upper part, indicating factory default.

**Step 2:** Pressing the ( **SOURCE** ) key, LCD displays "SAVE" symbol on the upper part for 1s. All settings are defaulted as below:

AP.OFF: 10min.

BL.OFF: 10sec.

TMP.U: °C.

FRSET: 50 Hz.

### **Tips:**

Any change of setting to the above-mentioned function, press the ( **SOURCE** ) key to save the value. Any press of the ( **SOURCE** ) key saves the nearest setting value.

## **11 Adjusting Measurement Functions**

### **Environmental Requirements**

Ambient temperature: 23  $\pm$ 2°C

Relative humidity: 35% to 75% RH

Warm-up:

- Before using, warm up the calibrator for the period of time specified.
- Put the meter into the standard environment for 24 hours, and then turn on the power. Change the set into non-automatic power-off state and warm it up for one hour.

### **Caution:**

Power Supply: new alkaline size (AAA) battery type 7 is the best choice for adjustment.

### **Measurement Adjustment Operation**

Please undertake the adjustment following the sequence and points listed in Table 4.

Table 4 Adjustment Points of Measurement Functions

Range	Adjustment Point		Remarks
	0	F	
DCV_50mV	50mV	-	
DCV_500mV	500mV	-	
OHM_500 $\Omega$	0 $\Omega$	500 $\Omega$	2W connection
OHM_5K $\Omega$	0 $\Omega$	5K $\Omega$	2W connection

\* Applying reference input signals from the calibration standard as listed in the above table.

**Tips:**

- You can also select only the range in need of readjustment to adjust it separately.
- Always make zero-point (0) adjustments together with full-scale (F) adjustments.

Turn on the meter; press the **(SOURCE)** key while simultaneously holding down the **(MEASURE)** key into the source adjusting state, and then press the **(MEASURE)** key into the measurement adjusting state, press **(HOLD)** key , LCD shows “CAL” symbol on the assistance districts part of the LCD and the reference value and unit on the main districts part of the LCD.

**Tips:**

- If the battery level is below 25% full, the adjustment operation can't be operated. And the LCD shows “ERR” in the lower part.

## 11.1 Adjusting all ranges of the DC Voltage

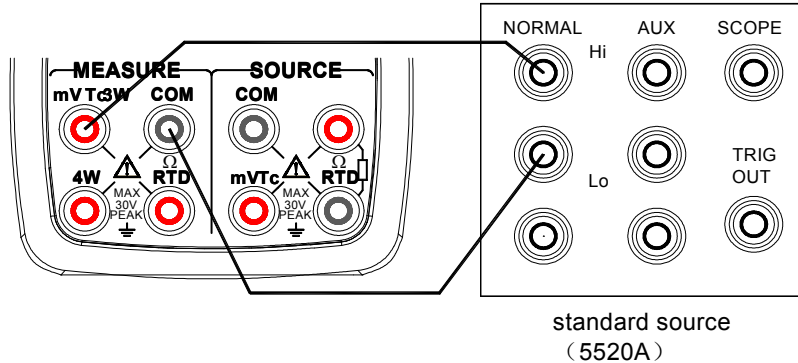

Figure 12 Calibrating DC voltage

- Step 1:** Make sure the lead cables for measurement are not connected to the measuring instrument under test.
- Step 2:** Using the ( **mV** ) key, select DC voltage adjust function.
- Step 3:** Connect the lead cables to the output terminals of the standard source as shown in Figure 12.
- Step 4:** Pressing the ( **RANGE** ) key selects the range.
- Step 5:** Pressing the ( **HOLD** ) key enters the measurement CAL mode. The LCD shows the present adjusting point “CA:0” in the assistance districts part of the LCD and the reference voltage and unit needed for the point in the main districts part of the LCD.
- Step 6:** Pressing the ( **AVG** ) key saves the adjusted value and the LCD shows “SAVE” symbol in the upper

part for 2 seconds.

**Step 7:** Pressing the **(HOLD)** key exits the CAL mode.

**Step 8:** By repeating from step 4 to step 7 until all ranges have been adjusted.

**Tips:**

- Adjustment to the DC voltage of 50mV range calibrates the TC temperature measurement range at the same time.

## 11.2 Adjusting all ranges of ohms

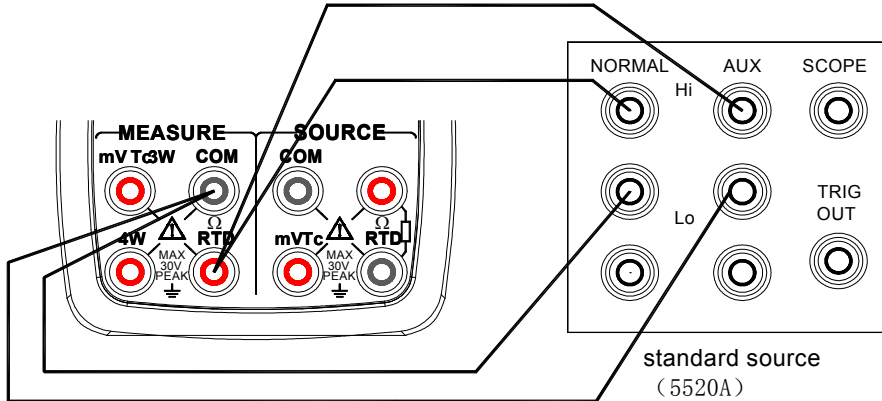

Figure 13 Calibrating all ranges of ohms

**Step 1:** Make sure the lead cables for measurement are not connected to the measuring instrument under test.

**Step 2:** Using the ( **OHM** ) key, select ohm adjust function.

**Step 3:** Connect the lead cables to the output terminals of the standard source as shown in Figure 13.(The 2 wire compensation of 5520A must be open )

**Step 4:** Pressing the ( **RANGE** ) key selects the range.

**Step 5:** Pressing the ( **HOLD** ) key enters the ohm CAL mode. The LCD shows the present adjusting point “CAL:0” in the assistance districts part of the LCD and the reference resistance and unit needed for the point in the main districts part of the LCD.

**Step 6:** Pressing the ( **AVG** ) key saves the adjusted value and the LCD shows “SAVE” symbol in the upper part for 2 seconds.

**Step 7:** Pressing the ( **RJ-ON** ) key causes the adjusting point shifting between CAL:0 and CAL:F. The LCD shows the reference resistance and unit needed for the point in the main districts part.

**Step 8:** Pressing the ( **AVG** ) saves the adjusted value and the LCD shows “SAVE” symbol in the upper part for 2 seconds.

**Step 9:** Pressing the ( **HOLD** ) key exits the CAL mode.

**Step 10:** By repeating from step 4 to step 9 until all ranges have been adjusted.

**Caution:**

- Make sure the previous adjusting point has been saved before shifting to another one.

**Tips:**

- Adjustment to the ohms calibrates the RTD temperature measurement range at the same time.

## **12 Adjusting Source Functions**

## Environmental Requirements

Ambient temperature: 23  $\pm$ 2°C

Relative humidity: 35% to 75% RH

Warm-up:

- Before using, warm up the calibrator for the period of time specified.
- Set the meter into the standard environment for 24 hours, and then turn on the power. Change the set into non-automatic power-off state and warm it up for one hour.

Power Supply: new alkaline size (AAA) battery type 7 is the best choice for adjustment.

Source Adjustment Operation:

Table 5 Adjustment Points of Source Functions

Range	Adjustment Point *					Remarks
	0	A	F	-0	-F	
DCV_100mV	0	/	100mV	/	/	
DCV_1000mV	0	0	1000mV	/	/	
OHM_400 $\Omega$ /1mA	0 $\Omega$	/	400 $\Omega$	-0 $\Omega$	-400 $\Omega$	I = $\pm$ 1mA
OHM_400 $\Omega$ /0.1mA	0 $\Omega$	/	400 $\Omega$	-0 $\Omega$	-400 $\Omega$	I = $\pm$ 0.1mA
OHM_4k $\Omega$ /0.1mA	0 $\Omega$	/	4k $\Omega$	-0 $\Omega$	-4k $\Omega$	I = $\pm$ 0.1mA

\* Adjusting the displayed value same with the reading of the digit meter when the present calibrator is stabilized.

- You can calibrate a desired function and range separately.
- You must calibrate all the calibrating points of the selected range together.

- When adjusting resistance source, the exciting current is (+) for adjustment point “0” and “F”, and is (-) for adjustment point “-0” and “-F”.

Turn on the meter; press the (**SOURCE**) key while simultaneously holding down the (**MEASURE**) key enters the source calibration state. LCD shows “CA-0” symbol on the assistance districts part, the present calibrating point on the main districts part and the high 5 digits of the responding value and its unit. The digit in the right on the assistance districts part is the lowest digit of the value.

Tips:

If the battery level is below 25% full, the adjustment operation can't be operated. And the LCD shows "ERR" in the lower part.

## 12.1 Adjusting Voltage Source

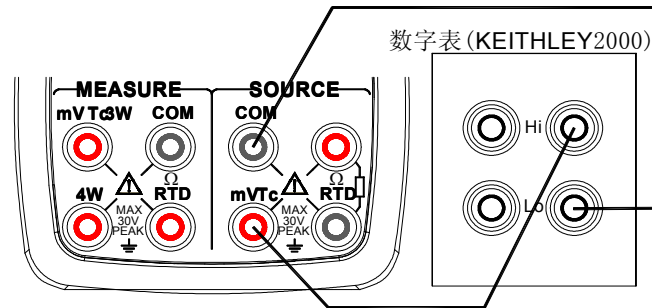

Figure 14 Adjusting voltage source

**Step 1:** Using the (**mV**) key, select DC voltage function. Connect the lead cables for measurement to the standard digital meter as shown in Figure 14.



**Step 2:** Pressing the (**RANGE**) key selects the right range.

**Step 3:** The LCD shows “CA-0” or “CA-F” symbol on the associate districts part and the calibrator is ready for the zero-point or F-point adjustment of source functions. The LCD shows the highest five digits and its unit in the main districts part and the lowest digit of the calibrated sourced value in the right of the assistance districts part respectively.

**Step 4:** Read the calibrator output on the calibration standard. Then, using the pair of (▲) / (▼) keys, adjust the reading so that it matches the measured CAL adjustment setpoint. In the CAL mode, the right pair of (▲) / (▼) keys are used to increase or decrease the least-significant digit, (the digit in the right of the assistance districts LCD part).

**Step 5:** Press the (**ZERO**) key to save the CAL adjustment reading.

**Step 6:** Pressing the (**4/3/2W**) key shifts to the next setpoint.

**Step 7:** By repeating steps 3 to 6, you can adjust all the adjustment point assigned to that range.

**Step 8:** By repeating steps 2 to 7, you can adjust all ranges of the DC voltage source function.

**Note:**

- Adjustment to the 100mV range calibrates the TC temperature measurement range at the same time.
- Make sure the previous adjusting point has been saved before shifting to another one.

## 12.2 Adjusting Resistance Source

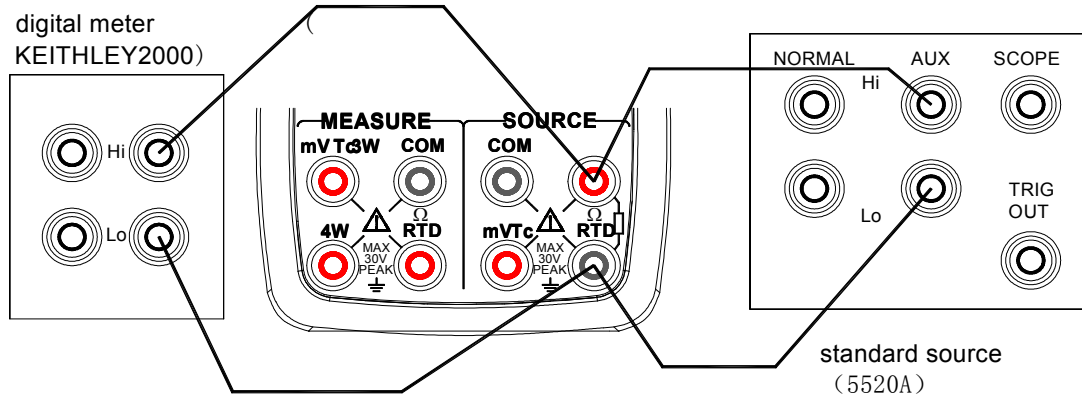

Figure 15 Adjusting resistance source

**Step 1:** Using the (OHM) key, select resistance function. Connect the lead cables for measurement to the standard digital meter as shown in Figure 15.

**Step 2:** Pressing the (RANGE) key selects the right range.

**Step 3:** The LCD shows “0” or “F” symbol on the left of the assistance districts part and the calibrator is ready for the zero-point or F-point adjustment of source functions. The LCD shows the highest five digits and its unit in the main districts part and the lowest digit of the calibrated sourced value in the right of the assistance districts part respectively.

**Step 4:** Read the calibrator output on the calibration standard. Then, using the pair of (▲) / (▼) keys, adjust

the reading so that it matches the measured CAL adjustment setpoint. In the CAL mode, the right pair of (▲) / (▼) keys are used to increase or decrease the least-significant digit, (the digit in the right of the assistance districts LCD part).

**Step 5:** Press the (ZERO) key to save the CAL adjustment reading.

**Step 6:** Pressing the (4/3/2W) key shifts to the next setpoint.

**Step 7:** By repeating steps 3 to 6, you can adjust all the adjustment point assigned to that range.

**Step 8:** By repeating steps 2 to 7, you can adjust all ranges of the DC voltage source function.

**Note:**

- In ohm calibration function, you can differentiate the negative exciting calibration from the left “-” mark on the lower part. The value of the exciting current is indicated by the digit on the top right corner.(unit :mA)
- Make sure to preserve the calibrating value before changing the calibrating point or range. Otherwise, the previous reading won't be saved if the point or range is changed.
- Calibration of the ohm 400  $\Omega$  and ohm 4K  $\Omega$  means calibrating all ranges of the RTD.
- In 400  $\Omega$  range resistance calibration:

1) Adjusting of inner variance

Make sure the applied voltage between the H and L terminals is within  $\pm 20$  uV, when setting 0.00  $\Omega$  resistance. If the voltage exceeds the range, the calibrator needs internal adjustment, then contact the vendor from whom you purchased the calibrator.

2) Noting exciting current of sourcing resistance

Calibration of the 400  $\Omega$  resistance range requires 2 exciting currents of 0.1mA and 1mA from external devices, of which the range is calibrated respectively.

## 13 Replacing Batteries or fuse:

### ⚠Warning

To avoid possible electric shock, remove the test leads from the calibrator before open the battery door. And make sure the battery door is tightly closed before turning on the calibrator.

### Caution

- To avoid possible linkage of the liquid and explosion of the battery, make sure to place the battery with right polarity.
- Do not operate the battery in short-circuit.
- Do not disassemble or heating the battery or throw them into the fire
- When replacing, use only four same specified ones.
- Take out the battery if you don't operate the meter for a long time.

**Step 1:** Remove the test leads and Charger before replacing batteries or fuse, and turn off the meter.

**Step 2:** Remove the protector as shown in Figure 16. With a standard blade hand screwdriver, turn each battery door screw a quarter counterclockwise to remove the battery door.

**Step 3:** Replace with four new AAA alkaline batteries under the instructions shown on the battery door. Or replace the blown fuses with same type F1 (50mA/250V).

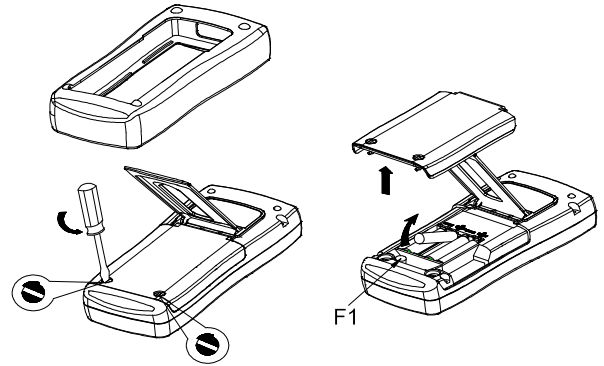

Figure 16 Replacing batteries and fuses

**Step 4:**Reinstall and tighten the battery door, put on the protector before using the meter.

## 14 How to use the charger

### Warning

- The charger could be used only to specified product.
- Make sure the voltage of the AC power is same with the given voltage of the charger before connecting them.
- Do not shut circuit the output plug of the charger.
- Do not charge non-Ni-Cd, non-Ni-MH battery or wasted battery.

**Step 1:**Turn off the calibrator.

**Step 2:**Connect the plug into the charging jack of the terminal.

**Step 3:**Plug the charger into the AC power.

### **Note:**

In normal charging function, the indicating light of the charger lights on.

When finished, the charging function stops automatically, and the indicating light becomes dark.

Blinking of the indicating light means the charger is not connected or no battery is inside.

### **Note:**

Do not use the calibrator when it undergoes charging, otherwise, the charging will be prolonged.

## 15 Maintenance

### 15.1 cleaning the calibrator

### **⚠Warning**

To avoid electrical shock or damaging the meter, serve the meter only by the replacement parts specified and never get water inside the case.

### **Caution**

To avoid damaging the plastic lens and case, do not use solvents or abrasive cleansers.

Clean the Calibrator with a soft cloth dampened with water or water and mild soap.

## **15.2 Calibration or Sending to the Service Center**

Calibration, maintenance or repair work unmentioned in this manual should be undertaken by the experienced worker. If the meter operates abnormally, inspect the batteries first and replace them if necessary.

If you suspect that the meter has failed, review this manual to make sure you are operating it correctly.

If the meter still fails to operate properly, pack it securely (in its original container if available) and forward it, postage paid, to the nearest Service Center. The company assumes NO responsibility for damage in transit.

The Company guarantees a rapid repair and maintenance and delivers the meter back as soon as possible. Please refer to the Warranty. If the warranty is due, you will be billed for the maintenance and repair work. If the calibrator or the pressure module is not within the Warranty range, you can contact the warranted service center for enquiring about the expenditure. Please refer to the Chapter “Contact Us” to find a warranted service center.

## **15.3 Replacement of Parts**

All the types of parts are listed in Table 6, see Figure 17 as reference.

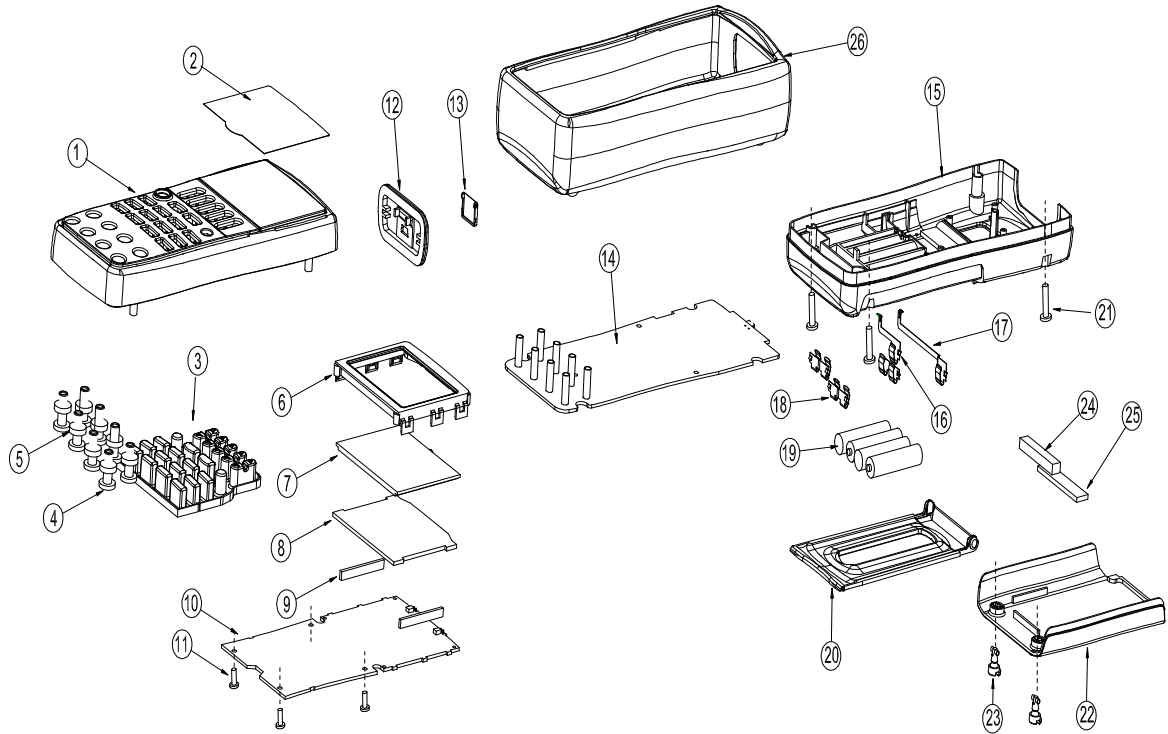

Figure 17. Replacing part

Table 6. Replacing parts

Item	Instruction	Quantity	Item	Instruction	Quantity
1	Top panel	1	16	Spring A	1
2	plastic lens	1	17	Spring B	1
3	Rubber Key	1	18	Spring C	3
4	Terminal Wrapper	8	19	AAA Alkaline battery	4
5	Terminal Gasket	8	20	Tilt-stand	1
6	LCD Frame	1	21	Screw M3*16	4
7	LCD	1	22	Battery Door	1
8	Backlight Panel	1	23	Plastic Screw	2
9	Conductive Rubber wire	2	24	Sponge: length × width × height = 40 × 6 × 6	1
10	LCD Circuit Panel	1	25	Sponge: length × width × height = 48 × 10 × 2.5	1
11	Screw M3*8	4	26	Outer Protector	1
12	Terminal Cover	1			
13	Cover Door	1			
14	Main Circuit Panel	1			
15	Bottom Panel	1			

## 16 Options



For more information about the options (see Figure 18) and its price, please contact the representative of the company.

Table 7 Options

No.	Name of the Options	Mode
1	CALCT Temperature Probe	A000019
2	TC Plug	R/S/K/E/J/T/N /B/L/U
3	Test Hoop	TP907110
4	CA Battery Parcel	A000021
5	CA Charger	A000020

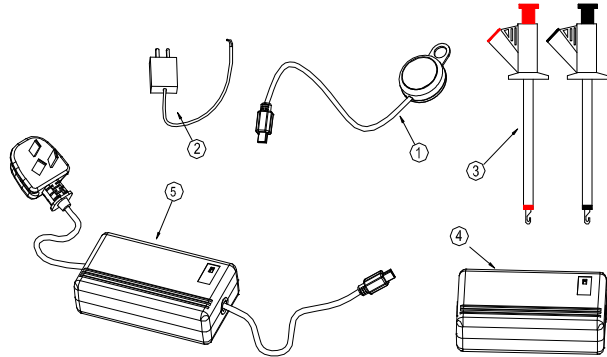

Figure 18 Options

## 17 Specifications

General Specifications for measure

These specifications assume:

- A 1-year calibration cycle
- An operating temperature of 18°C to 28°C
- Relative humidity of 35% to 70% (non\_condensing)

Accuracy is expressed as  $\pm$  (percentage of reading + percentage of range).

Function	Reference	Range	Resolution	Accuracy	Remark
DCV	50mV	-5.000~55.000mV	1 $\mu$ V	0.02+0.02	Input Resistance: 100M $\Omega$
	500mV	-50.00~550.00mV	10 $\mu$ V	0.02+0.01	
OHM	500 $\Omega$	0.00 $\Omega$ ~550.00 $\Omega$	0.01 $\Omega$	0.05+0.02	500 $\Omega$ : Excitation current: Approximately 1mA 5K $\Omega$ : Excitation current Approximately 0.1mA Open Circuit Voltage : about 2.5V; Does not include lead resistance;
	5K $\Omega$	0.0000 K $\Omega$ ~ 5.5000K $\Omega$	0.1 $\Omega$	0.05+0.02	
TC	R	0 $^{\circ}$ C~1767 $^{\circ}$ C	1 $^{\circ}$ C	0~500 $^{\circ}$ C : 1.8 $^{\circ}$ C	By using ITS-90 temperature scale; The accuracy does not include the error of internal temperature compensation caused by a sensor;
	S	0 $^{\circ}$ C~1767 $^{\circ}$ C		500 ~ 1767 $^{\circ}$ C : 1.5 $^{\circ}$ C	
	K	-100.0 $^{\circ}$ C~1372.0 $^{\circ}$ C	0.1 $^{\circ}$ C	-100.0~0.0 $^{\circ}$ C : 1.2 $^{\circ}$ C 0.0~1372.0 $^{\circ}$ C : 0.8 $^{\circ}$ C	
	E	-50.0 $^{\circ}$ C~850.0 $^{\circ}$ C		-50.0 $^{\circ}$ C~0.0 $^{\circ}$ C : 0.9 $^{\circ}$ C 0.0~850.0 $^{\circ}$ C : 1.5 $^{\circ}$ C	
	J	-60.0 $^{\circ}$ C~1120.0 $^{\circ}$ C		-60.0~0.0 $^{\circ}$ C : 1.0 $^{\circ}$ C 0.0~1120.0 $^{\circ}$ C : 0.7 $^{\circ}$ C	

	T	-100.0°C~400.0°C		-100.0~0.0°C : 1.0°C 0.0~400.0°C : 0.7°C	
	N	-200.0°~1300.0°C		-200.0~0.0°C : 1.5°C 0.0 ~ 1300.0°C : 0.9°C	
	B	600°C~1820°C	1°C	600~800°C : 2.2°C 800~1000°C : 1.8°C 1000~1820°C: 1.4°C	
	L	-60°C~900°C	0.1°C	-60.0~0.0°C : 0.7°C 0.0~900.0°C: 0.5°C	
	U	-100°C~600°C	0.1°C	-100.0~0.0°C : 0.7°C 0.0~600.0°C : 0.5°C	
RTD	Pt100 385	-200.0°C~800.0°C	0.1°C	-200.0°C ~ 0.0°C 0.5°C 0.0°C ~ 400.0°C 0.7°C 400.0°C ~ 800.0°C 0.8°C	By using temperature scale ITS-90. Does not include lead resistance. Assuming all three RTD leads are matched for 3- w input.

	Pt1000 385	-200.0°C~630.0°C	0.1°C	-200.0 ~ 100.0°C : 0.8°C 100.0 ~ 300.0°C : 0.9°C 300.0 ~ 630.0°C : 1.0°C	
	Pt200 385	-200.0°C~630.0°C		-200.0~100.0°C : 0.8°C 100.0~300.0°C : 0.9°C 300.0~630.0°C : 1.0°C	
	Pt500 385	-200.0°C~630.0°C			
	Cu10	-100.0°C~260.0°C	0.1°C	1.8°C	
	Cu50	-50.0°C~150.0°C		0.7°C	
CONT.	500Ω	≤50Ω sound	0.01Ω		Excitation current Approximately :1mA

Other feature:

- Rate: 2 Readings per Second about
- DCV  
Normal Mode Rejection Ratio (NMRR) ≥60dB (at 50Hz or 60Hz)

Common Mode Rejection Ratio (CMRR)  $\geq 120\text{dB}$  (at 50Hz or 60Hz)

- Temperature Coefficient: 0.1 times the applicable accuracy specification per degree C for 5°C to 18°C and 28°C to 50°C
- The range of the internal temperature compensation sensor is from -0°C to 50°C, compensation error  $\leq \pm 0.5^\circ\text{C}$
- The accuracy of the temperature probe:  $\pm 0.2^\circ\text{C}$ . The range of the measured temperature is form - 20°C-100°C.
- Maximum voltage between V  $\Omega$  Hz terminal and COM terminal: 30 Vpk

#### General Specifications for Source

These specifications assume:

A 1-year calibration cycle

An operating temperature of 18°C to 28°C (64.4°F~82.4°F)

Relative humidity of 35% to 70% (non\_condensing)

Accuracy is expressed as  $\pm$  (percentage of set value + percentage of range)

Function	Reference	Range	Resoluti on	Accuracy	Remark
DC voltage	100mV	-10.000mV ~ 110.000mV	1 $\mu$ V	0.02+0.01	Maximum output current: 0. 5mA
	1000mV	-100mV ~ 1100mV	10 $\mu$ V	0.02+0.01	Maximum output current: 2mA

Resistance	400Ω	0.00Ω ~ 400.00Ω	0.01Ω	0.02+0.02	Excitation current: ± 0.5–3 mA; if ± 0.1–0.5, add 0.1Ω; Accuracy does not include lead resistance;
	4KΩ	0.0000 KΩ ~ 4.0000 KΩ	0.1Ω	0.05+0.025	Excitation current: ±0.05 –0.3mA; Does not include lead resistance;
TC	R	0°C~1767°C	1°C	0~100°C : 1.5°C 100~1767°C: 1.2°C	By using ITS-90 temperature scale; The accuracy does not include the error of internal temperature compensation caused by a sensor;
	S	0°C~1767°C		0~100°C : 1.5°C 100~1767°C: 1.2°C	
	K	-200.0°C~1372.0°C	0.1°C	-200.0~-100.0 : 0.6°C -100.0~400.0°C:0.5°C 400.0~1200.0°C: 0.7°C 1200.0~1372.0 :0.9°C	
	E	-200.0°C~1000.0°C		-200.0~-100.0 : 0.6°C -100.0~600.0°C:0.5°C 600.0~1000.0°C: 0.4°C	
	J	-200.0°C~1200.0°C		-200.0~-100.0 : 0.6°C -100.0~800.0°C:0.5°C 800.0~1200.0°C: 0.7°C	

	T	-250.0°C~400.0°C		-250.0~400.0°C: 0.6°C	
	N	-200.0°C~1300.0°C		-200.0~-100.0°C:1.0°C -100.0~900.0°C: 0.7°C 900~1300.0°C: 0.8°C	
	B	600°C~1820°C	1°C	600~800°C : 1.5°C 800~1820°C: 1.1°C	
	L	-200.0°C ~ 900.0°C	0.1°C	-200.0~0°C : 0.7°C 0~900.0°C:0.5°C	
	U	-200.0°C ~ 600.0°C	0.1°C	-200.0~0°C : 0.7°C 0~600.0°C:0.5°C	
RTD	Pt100 385	-200.0°C ~ 800.0°C	0.1°C	-200.0~0.0°C : 0.3°C 0.0~400.0°C : 0.5°C 400.0~850.0°C: 0.8°C	By using temperature scale ITS-90 Excitation current: ±0.5~±3mA for Pt100, Cu10, Cu50 add 0.5°C when excitation current is ±0.1mA-0.5mA; Excitation current: ±0.05mA ~ ±0.3mA for PT200, PT500, PT1000; Does not include lead resistance.
	Pt200 385	-200.0°C~630 .0°C		-200.0~100.0°C: 0.8°C 100.0~300.0°C : 0.9°C 300.0~630.0°C : 1.0°C	
	Pt500 385	-200.0°C ~ 630.0°C		-200.0~100.0°C: 0.4°C 1000.0~300.0°C :0.5°C 300.0~630.0°C : 0.7°C	

	Pt1000 385	-200.0°C ~ 630.0°C		-200.0~100.0°C : 0.2°C 100.0~300.0°C : 0.5°C 300.0~630.0°C : 0.7°C	
	Cu10	-100.0°C ~ 260.0°C		1.8°C	
	Cu50	-50.0°C ~ 150.0°C		0.6°C	

Other feature:

- Temperature Coefficient: 0.1 times the applicable accuracy specification per degree C for 5°C to 18°C and 28°C to 50°C.
- The range of the internal temperature compensation sensor is from 0°C to 50°C, compensation error  $\leq \pm 0.5^\circ\text{C}$ .  
Maximum voltage between any output terminal and earth: 30Vpk
- The accuracy of the temperature probe:  $\pm 0.2^\circ\text{C}$ , the range of the measured temperature is from -20°C-100°C.

## 18 Points for Attention to Use of Operation Instruction

- The present operation instruction is subject to change without notice.
- The content of the operation instruction is regarded as correct. Whenever any user finds its mistakes,



omission, etc, he or she is requested to contact the manufacturer.

- The present manufacturer is not liable for any accident and hazard arising from any misoperation.
- The functions described in this operation instruction should not be used as grounds to apply this product to a particular purpose.